

DLA SERIES

3½ DIGIT LED DPM INSTALLATION SHEET

PANEL CUTOUT, DIMENSIONS & WIRING

BEZEL ASSEMBLY

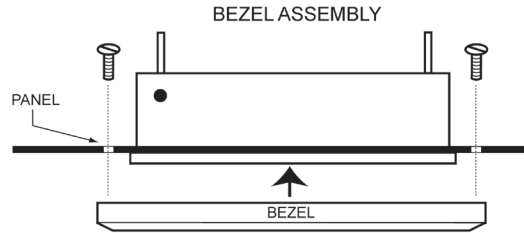
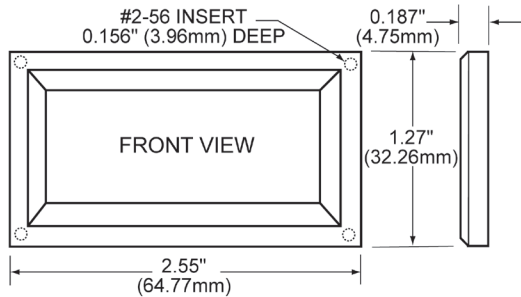

RECOMMENDED PANEL CUTOUT

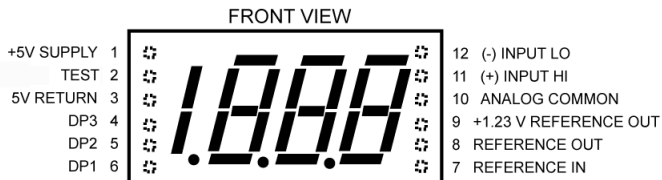
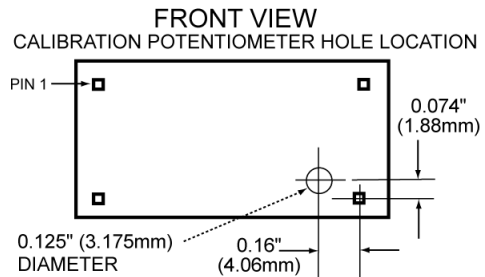
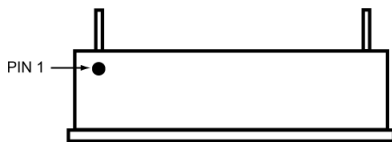
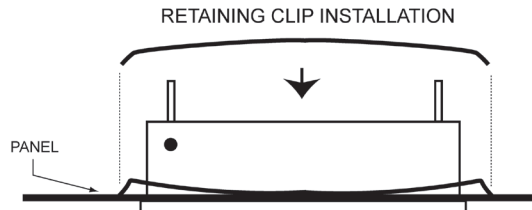
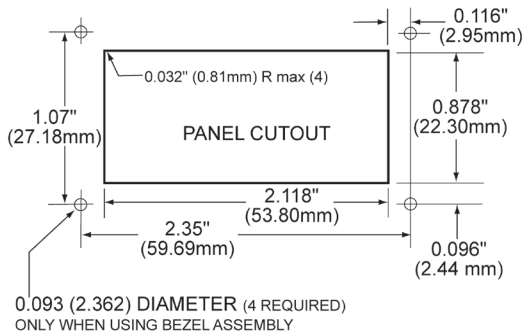

Pin Dimensions: 0.025" (0.626 mm) x 0.025" (0.626 mm)

To enable DPs (Pin 4-6) connect to Pin 3 (5V return)

Pin 3 should be tied to Pin 12 for normal operation

Connect Pins 7 & 8

